

NEW KEYS COLLECTION

2024
MARCH

NR.
03



NETWORK WITH US













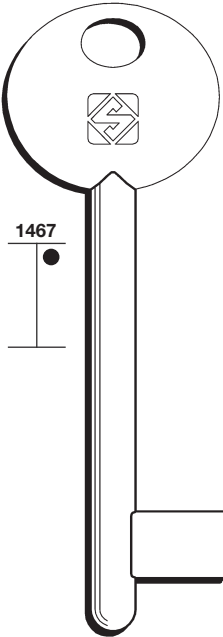

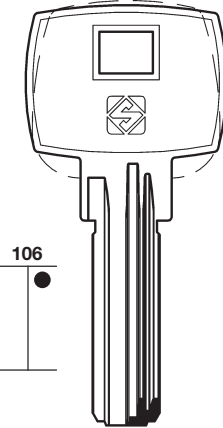

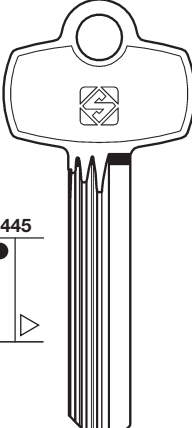







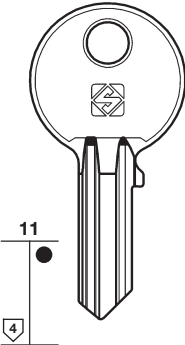
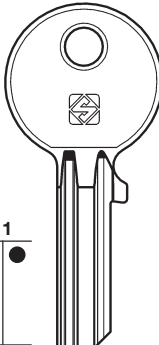
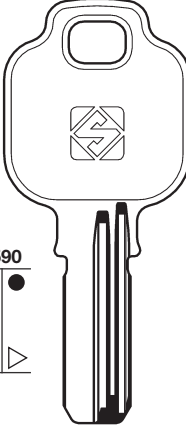
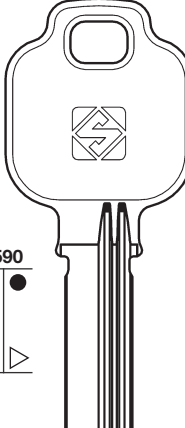



2024 NEW KEYS COLLECTION

NEW KEYS



Silca key blanks are compatible with third party manufacturers' cylinders specified here below:

AGB*		AL AHRAM*		BEST*	
					
1467	6AGB7	106	AHR4	445	BES23 TB
					
8 052782 040738	8 052782 040738	8 052782 041711	8 052782 041711	8 052782 044781	8 052782 044781
Box of 25	Box of 25	Box of 50	Box of 50	Box of 100	Box of 100
CISA*		DABEL*			
					
11	11	1590	1590		
4	5	5	6		
					
CS190	CS191	DBL1	DBL3		
					
					
8 052782 043708	8 052782 043715	8 052782 042084	8 052782 043449		
Box of 100	Box of 100	Box of 50	Box of 50		

- AGB* (IT)
- AL AHRAM* (EG)
- BEST* (US)
- CISA* (IT)
- DABEL* (RS)

(*) This is a trademark of a third party not affiliated nor linked with Silca S.p.A. or the dormakaba Group. Silca S.p.A. and dormakaba Group do not own any intellectual property right nor have been granted any license with regard to such trademark, which is hereby used only to indicate the intended purpose of Silca's products.











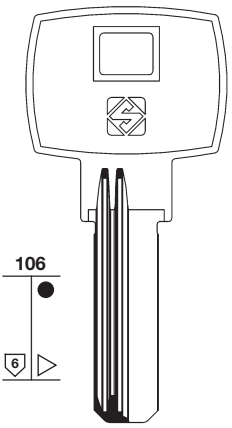

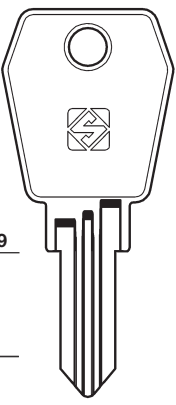
2024 NEW KEYS COLLECTION

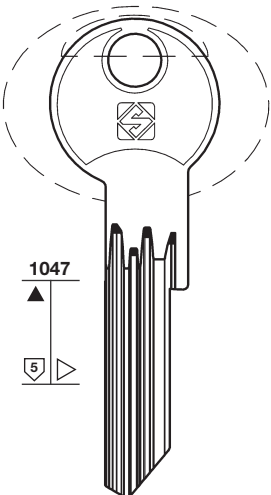
NEW KEYS

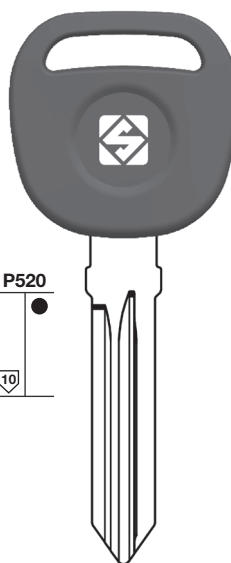

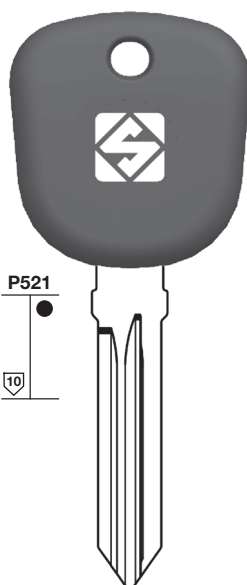
Silca key blanks are compatible with third party manufacturers' cylinders specified here below:

DABEL*	EURO LOCKS*	FAB*	
 <p>106 6 DBL2R</p>  <p>8 052782 042091 Box of 50</p>	 <p>879 7 EU25</p>  <p>8 052782 043722 Box of 100</p>	 <p>1047 5 FB143X</p>  <p>8 052782 042503 Box of 50</p>	<p>DABEL* (RS)</p> <p>EURO LOCKS* (BE)</p> <p>FAB* (CZ)</p> <p>GENERAL MOTORS* (US)</p>
GENERAL MOTORS*			
 <p>P520 10 B111P</p>  <p>8 052782 041735 Box of 25</p>	 <p>P521 10 B111TE</p>  <p>8 052782 042602 Bag of 1</p> <p>8 052782 042619 Bag of 5</p>		<p>(*) This is a trademark of a third party not affiliated nor linked with Silca S.p.A. or the dormakaba Group. Silca S.p.A. and dormakaba Group do not own any intellectual property right nor have been granted any license with regard to such trademark, which is hereby used only to indicate the intended purpose of Silca's products.</p>











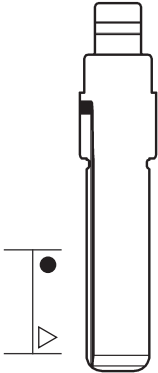
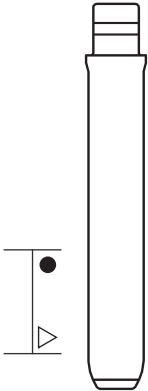
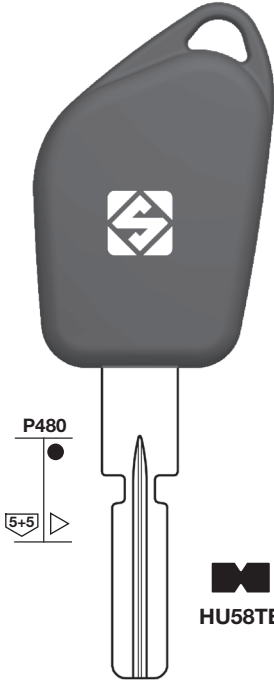

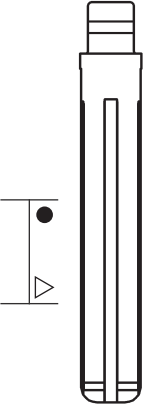
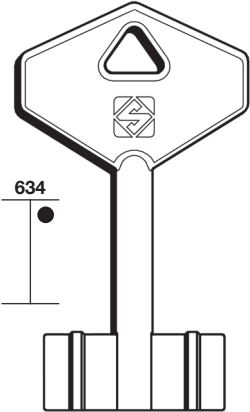
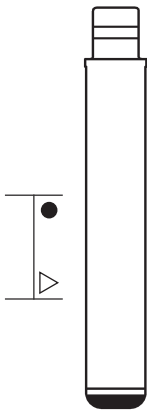

2024 NEW KEYS COLLECTION

NEW KEYS



Silca key blanks are compatible with third party manufacturers' cylinders specified here below:

HUF*			HUF* (DE)
			HYUNDAI* (KR)
			ITAL* (IT)
HU66CH1	HU134CH	HU58TE	KIA* (KR)
			
Pack of 1	Pack of 1	Box of 5	
HYUNDAI*	ITAL*	KIA*	
			
			
HYN20CH	5IT9	KIA9CH	
			
Pack of 1	Box of 25	Pack of 1	

(*) This is a trademark of a third party not affiliated nor linked with Silca S.p.A. or the dormakaba Group. Silca S.p.A. and dormakaba Group do not own any intellectual property right nor have been granted any license with regard to such trademark, which is hereby used only to indicate the intended purpose of Silca's products.















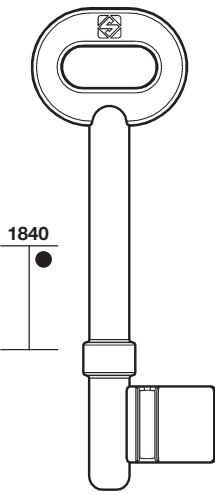

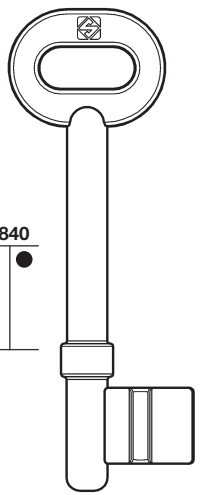

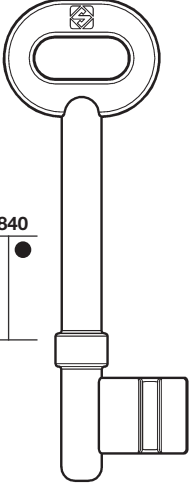
2024 NEW KEYS COLLECTION

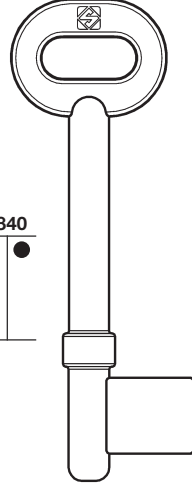
NEW KEYS

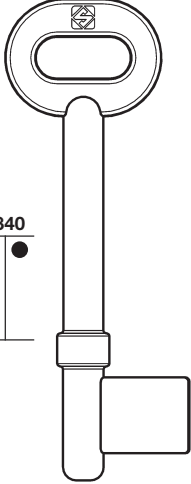

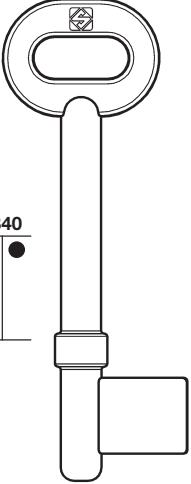
Silca key blanks are compatible with third party manufacturers' cylinders specified here below:

KYMCO*	LEGGE*			
 <p>Magnetic key</p> <p>Model: PEOPLE S Year: 2012-2017</p> <p>Model: X-TOWN CT Year: from 2017</p>    <p>8 052782 044200</p> <p>Box of 10</p>	 <p>1840</p>  <p>6LEG1-B1</p>  <p>8 052782 039664</p> <p>Box of 25</p>	 <p>1840</p>  <p>6LEG1-B2</p>  <p>8 052782 039671</p> <p>Box of 25</p>	<p>KYMCO* (KR)</p> <p>LEGGE* (GB)</p>	
LEGGE*				
 <p>1840</p>  <p>6LEG1-B3</p>  <p>8 052782 039688</p> <p>Box of 25</p>	 <p>1840</p>  <p>6LEG1-B4</p>  <p>8 052782 039695</p> <p>Box of 25</p>	 <p>1840</p>  <p>6LEG1-B5</p>  <p>8 052782 040608</p> <p>Box of 25</p>	 <p>1840</p>  <p>6LEG1-B6</p>  <p>8 052782 040615</p> <p>Box of 25</p>	<p>(*) This is a trademark of a third party not affiliated nor linked with Silca S.p.A. or the dormakaba Group. Silca S.p.A. and dormakaba Group do not own any intellectual property right nor have been granted any license with regard to such trademark, which is hereby used only to indicate the intended purpose of Silca's products.</p>



2024 NEW KEYS COLLECTION

NEW KEYS



Silca key blanks are compatible with third party manufacturers' cylinders specified here below:

LOCKWOOD*

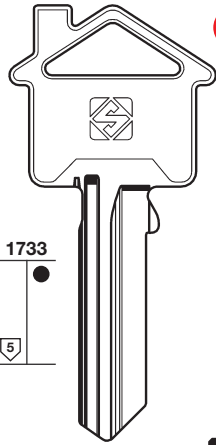

LW4BB



Box of 10

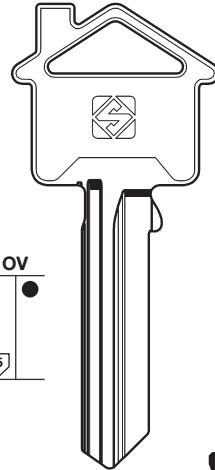

LW5BB



Box of 10

LOCKWOOD* (AU)

MOTTURA* (IT)

MOTTURA*

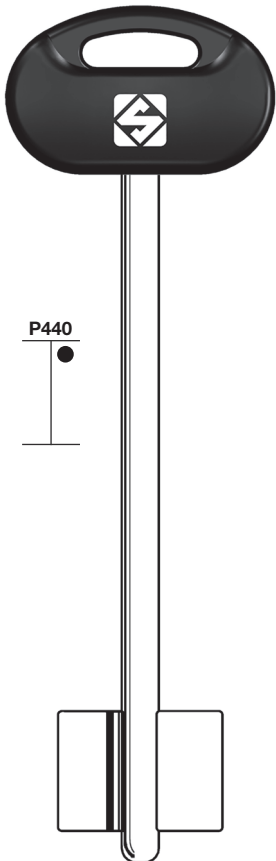

5MT29BP



Box of 25

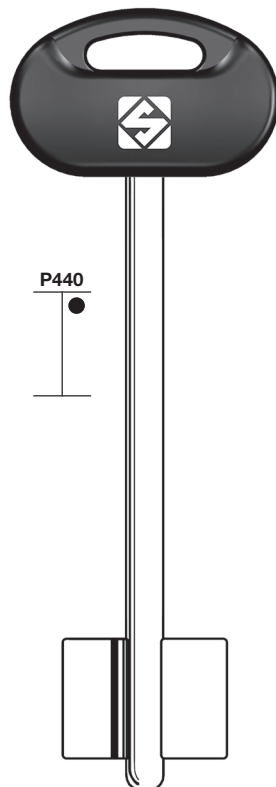

5MT27BP



Box of 25

(*) This is a trademark of a third party not affiliated nor linked with Silca S.p.A. or the dormakaba Group. Silca S.p.A. and dormakaba Group do not own any intellectual property right nor have been granted any license with regard to such trademark, which is hereby used only to indicate the intended purpose of Silca's products.



2024 NEW KEYS COLLECTION

NEW KEYS



Silca key blanks are compatible with third party manufacturers' cylinders specified here below:

NEMEF*		POWERLOCK*		SUZUKI*		TITAN*		UNIVERSAL*	
								<p>NEMEF*^(NL)</p> <p>POWERLOCK*^(DE)</p> <p>SUZUKI ^(JP)</p> <p>TITAN* ^(SI)</p> <p>UNIVERSAL</p>	
1841	1841	1385	Lock Systems: PL-700						
8 052782 041377	8 052782 041384	8 052782 042039							
Box of 25	Box of 25	Box of 50							

(*) This is a trademark of a third party not affiliated nor linked with Silca S.p.A. or the dormakaba Group. Silca S.p.A. and dormakaba Group do not own any intellectual property right nor have been granted any license with regard to such trademark, which is hereby used only to indicate the intended purpose of Silca's products.



2024 NEW KEYS COLLECTION

NEW KEYS



Silca key blanks are compatible with third party manufacturers' cylinders specified here below:

VACHETTE*

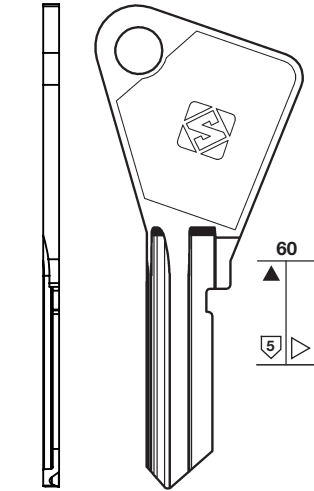

Shoulder milling view



VAC2SM



8 052782 033013

Box of 50

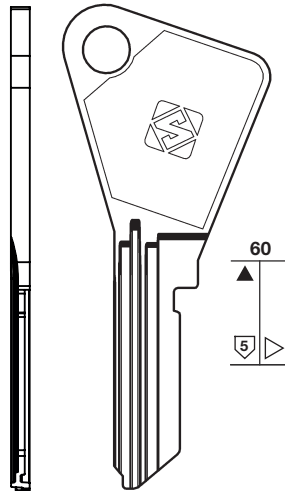

Shoulder milling view



VAC48SM



8 052782 032924

Box of 50

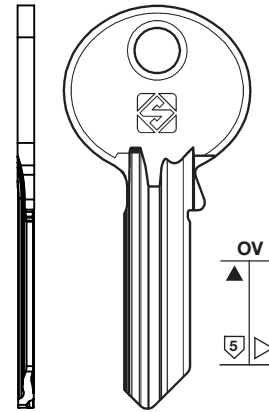

Shoulder milling view



VAC151SM



8 052782 032894

Box of 50

VACHETTE* (FR)

YALE* (GB)

YALE*

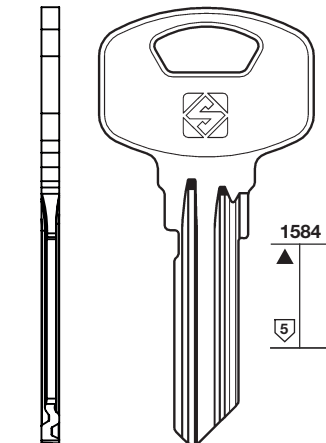

Shoulder milling view



YA116SM



8 052782 043968

Box of 50

Orig. code: 1109

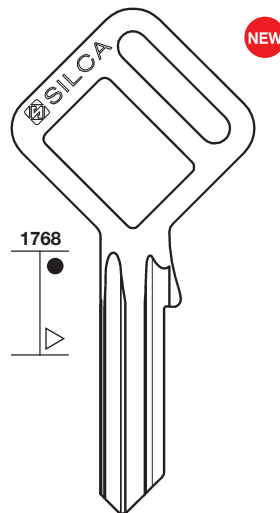

1768



YA226FZ



8 052782 042527

Box of 50 - Assorted colours

(* This is a trademark of a third party not affiliated nor linked with Silca S.p.A. or the dormakaba Group. Silca S.p.A. and dormakaba Group do not own any intellectual property right nor have been granted any license with regard to such trademark, which is hereby used only to indicate the intended purpose of Silca's products.



2024 NEW KEYS COLLECTION

NEW KEYS



Silca key blanks are compatible with third party manufacturers' cylinders specified here below:

ZADI*

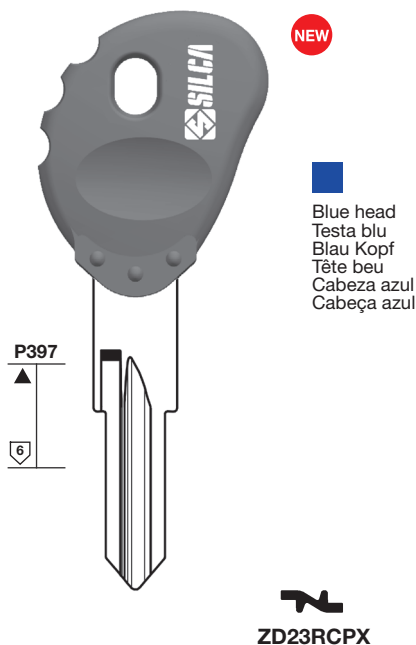
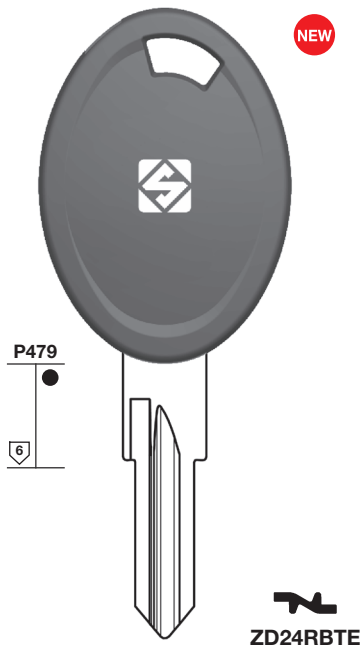

ZADI* (IT)

ZEISS IKON (DE)

ZEISS IKON*

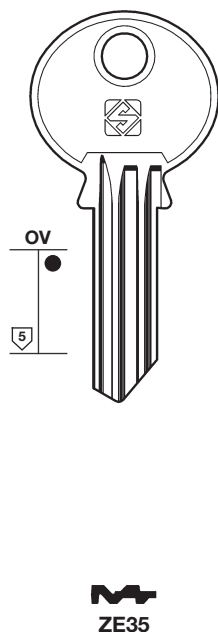
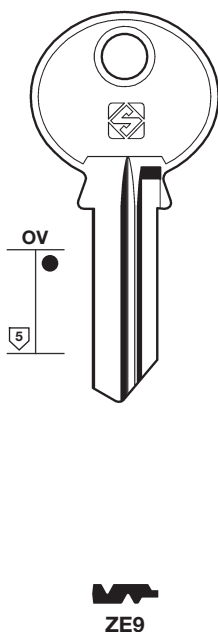

(*) This is a trademark of a third party not affiliated nor linked with Silca S.p.A. or the dormakaba Group. Silca S.p.A. and dormakaba Group do not own any intellectual property right nor have been granted any license with regard to such trademark, which is hereby used only to indicate the intended purpose of Silca's products.